

Worm Drive 14-2 GS

SPECIAL NON-SELF LOCKING WORM DRIVE ROTATORS FOR INCREASED ROTATION SPEED FOR GRAPPLE SAW

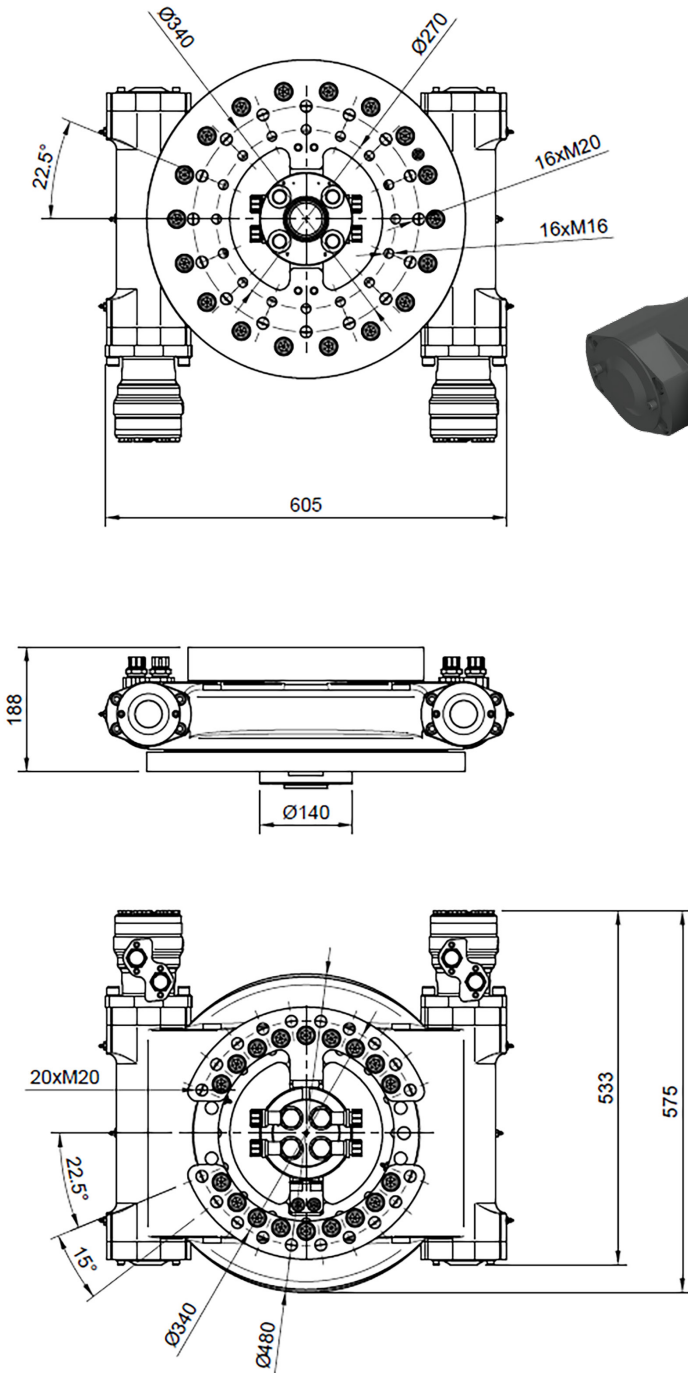

KEY FEATURES

- Low built
- High torque
- Exact positioning
- High axial and radial load capacity
- For grapple saw

MODEL SPECIFICATIONS

MODEL SPECIFICATIONS	Kg	ton	ton	Bar	Bar	l/min	l/min	Nm	ROTATION SPEED	G 1/2"	G 1/2"	ton
WDR 14-2 GS	153	19	7	250	120	100	2x25	5800	4,8 rpm	G 1/2"	G 1/2"	12-20

